

Article number: 20194B30B302SW

Description: E+G

T-angel clamps GN194-B30-B30-2-SW

## Measures

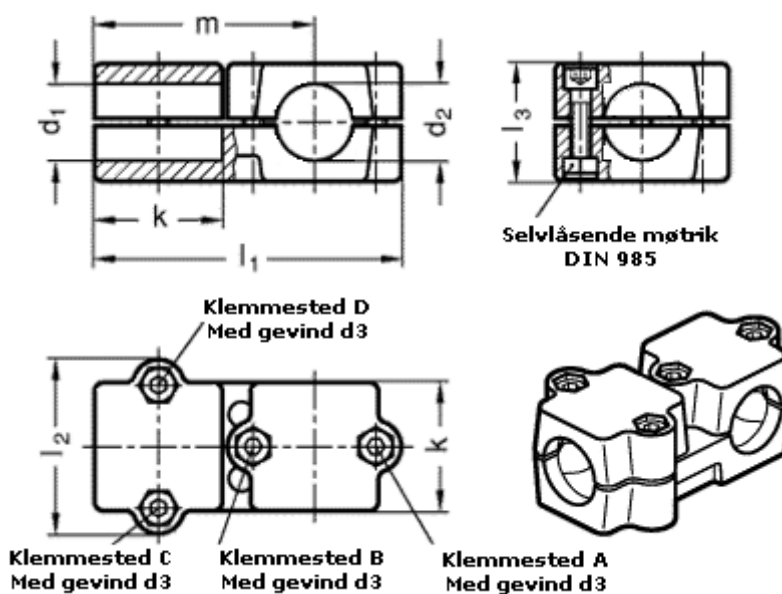

d1 = 30

d2 = 30

d3 = M 8

k = 50

l1 = 120

l2 = 68

l3 = 46

m = 85